

# contents

assembly hints

component installation methods

assembly procedure

theory of operation

schematics

troubleshooting

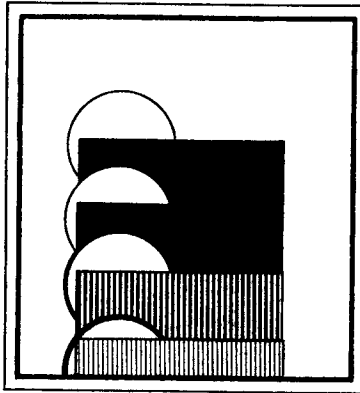

# 4K

## static ram

memory board

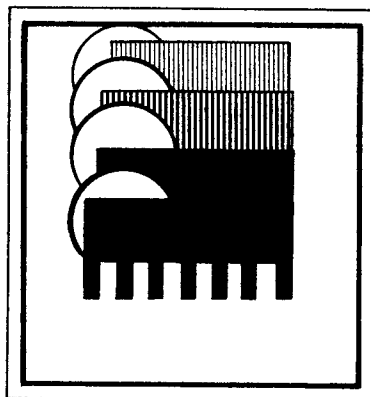

rev. 0



© mits 1976  
2450 Alamo SE  
Albuquerque, NM 87106

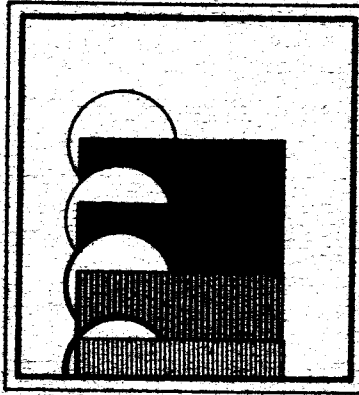

# 4K

**static ram**  
memory board

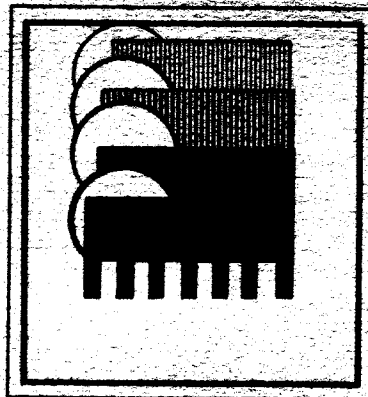

## **ASSEMBLY PROCEDURE**

Assembly Hints.....	page 2
Component Installation Methods.....	page 3
Assembly Procedure.....	page 9

88-4MCS  
 PARTS LIST  
 APRIL, 1976

BAG 1

2	74LS00	101069
1	74LS04	101042
3	74LS13	101124
2	74LS14	101123
2	74367	101040
1	7805	101074

BAG 2

32	2102A-4	101107
----	---------	--------

BAG 3

42	.1MF 12-16V	100348
----	-------------	--------

BAG 4

2	.01MF 16V-1KV	100321
1	1MF 20V	100325
3	33MF 16V	100326

BAG 5

1	4 Ohm 5W 10%	102007
2	100 Ohm $\frac{1}{2}$ W 10%	101924
2	2.2K $\frac{1}{2}$ W 10%	101945

BAG 6

5	6-32 x 3/8" Screw	100925
1	#6-32 Nut	100933
1	#6 Lock Washer	100942
1	Heat Sink (Large)	101870
2	Ferrite Beads	101876

BAG 7

34	16 Pin Socket	102103
8	14 Pin Socket	102102
1	Dip Switch (4-SPDT)	102321
2	Card Guides	101714
1	100 Pin Connector	101864

MISC.

1	P.C. Board	100187
1	4MCS Manual	101533

#### INTRODUCTORY NOTE

The 88-2MCS consists of the 88-4MCS PC Board and all parts except for the 16 memory I.C.s (2102A-4) and 16 sockets. The 16 memory I.C.s and sockets that are supplied should be placed in memory locations A0-A7 and B0-B7 only.

Do not install R3, 4 ohm, 5 watt resistor, if you are assembling the 88-2MCS.

# ASSEMBLY HINTS

Before beginning the construction of your unit, it is important that you read the "MITS Kits Assembly Hints" booklet included with your kit. Pay particular attention to the section on soldering, because most problems in the Altair occur as the result of poor soldering. It is essential that you use the correct type of soldering iron. A 25-30 watt iron with a chisel tip (such as an Ungar 776 with a 7155 tip) is recommended in the assembly hints booklet.

Some important warnings are also included in the hints booklet. Read them carefully before you begin work on your unit -- failure to heed these warnings could cause you to void your warranty.

Check the contents of your kit against the enclosed parts list to make sure you have all the required components, hardware and parts. The components are in plastic envelopes; do not open them until you need the components for an assembly step. You will need the tools called for in the "Kits Assembly Hints" booklet.

As you construct your kit, follow the instructions in the order they are presented in the assembly manual. Always complete each section before going on to the next. Two organizational aids are provided throughout the manual to assist you: 1) Boxed-off parts identification lists, with spaces provided to check off the components as they are installed; 2) Reproductions of the silk screens showing a) previously installed components, b) components being installed and c) components yet to be installed.

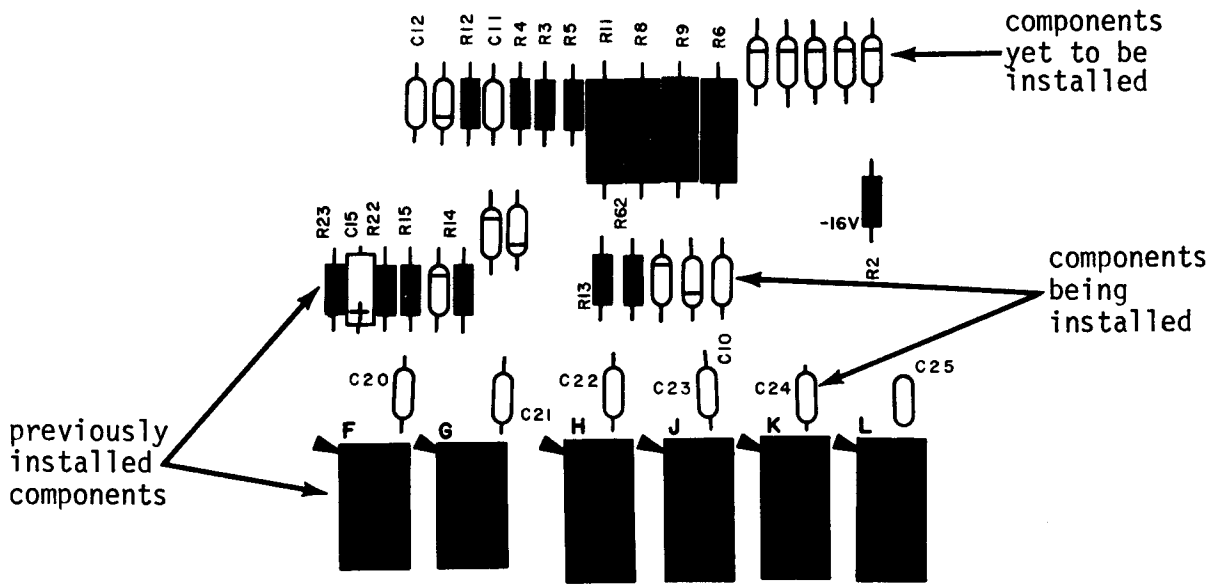

### COMPONENT INSTALLATION METHODS

This section of the manual describes the proper procedures for installing various types of components in your kit.

Read these instructions over very carefully and refer back to them whenever necessary. Failure to properly install components may cause permanent damage to the component or the rest of the unit; it will definitely void your warranty.

More specific instructions, or procedures of a less general nature, will be included within the assembly text itself.

Under no circumstances should you proceed with an assembly step without fully understanding the procedures involved. A little patience at this stage will save a great deal of time and potential "head-aches" later.

## SOCKET INSTALLATION

Install each socket according to the following procedure:

1. Be certain that the socket pins are straight. If any of the pins are bent, CAREFULLY straighten them with the tip of a small screwdriver.
2. Set the socket into place, and secure it with a piece of masking tape.
3. Turn the board over and solder each pin to the foil pattern of the back of the board. Be sure that EACH pin is soldered, and be careful not to leave any solder bridges.
4. Turn the board over again, and remove the masking tape.
5. After each socket is installed, check the corresponding socket off of the parts list on page 4.

## IC INSTALLATION

All ICs must be oriented so that the notched end is toward the end with the arrowhead printed on the PC board. Pin 1 of the IC should correspond with the pad marked with the arrowhead. If the IC does not have a notch on one end, refer to the chart on the preceding page for the identification of Pin 1.

### To prepare ICs for installation:

All ICs are damaged easily and should be handled carefully--especially static-sensitive MOS ICs. Always try to hold the IC by the ends, touching the pins as little as possible.

When you remove the IC from its holder, CAREFULLY straighten any bent pins using needle-nose pliers. All pins should be evenly spaced and should be aligned in a straight line, perpendicular to the body of the IC itself.

1. Orient the IC so that Pin 1 coincides with the arrowhead on the PC board.
2. Align the pins on one side of the IC so that just the tips are inserted into the proper holes on the board.
3. Lower the other side of the IC into place. If the pins don't go into their holes right away, rock the IC back, exerting a little inward pressure, and try again. Be patient. The tip of a small screwdriver may be used to help guide the pins into place. When the tips of all the pins have been started into their holes, push the IC into the board the rest of the way.
4. Tape the IC into place on the board with a piece of masking tape.
5. Turn the board over and solder each pin to the foil pattern on the back side of the board. Be sure to solder each pin and be careful not to leave any solder bridges.
6. Turn the board over again and remove the piece of masking tape.

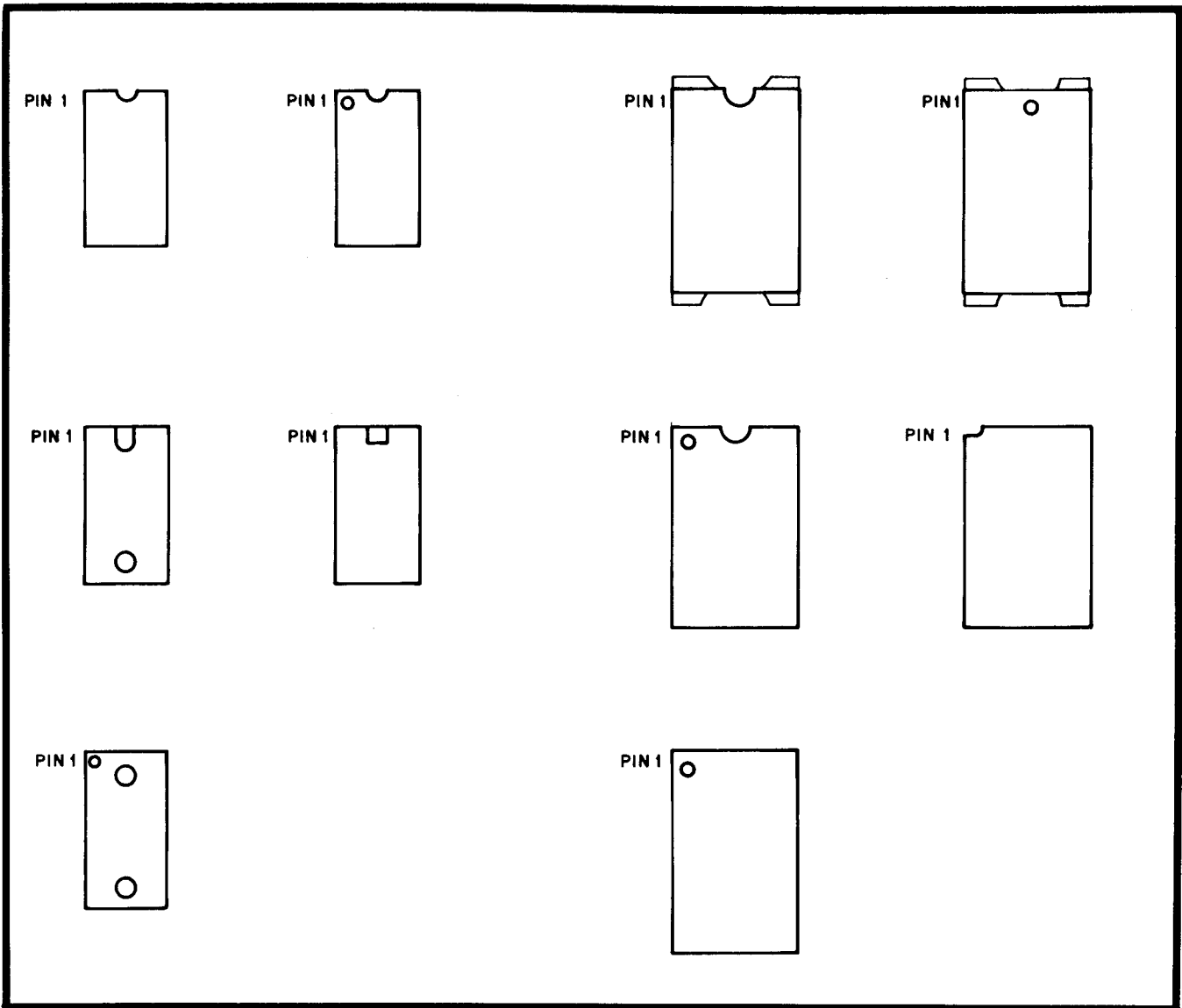

INTEGRATED CIRCUITS (IC's) CAN COME WITH ANY ONE OF, OR A COMBINATION OF, SEVERAL DIFFERENT MARKINGS. THESE MARKINGS ARE VERY IMPORTANT IN DETERMINING THE CORRECT ORIENTATION FOR THE IC's WHEN THEY ARE PLACED ON THE PRINTED CIRCUIT BOARDS. REFER TO THE ABOVE DRAWING TO LOCATE PIN 1 OF THE IC's, THEN USE THIS INFORMATION IN CONJUNCTION WITH THE INFORMATION BELOW TO PROPERLY ORIENT EACH IC FOR INSTALLATION.

**WARNING: INCORRECTLY ORIENTED IC's MAY CAUSE PERMANENT DAMAGE!**

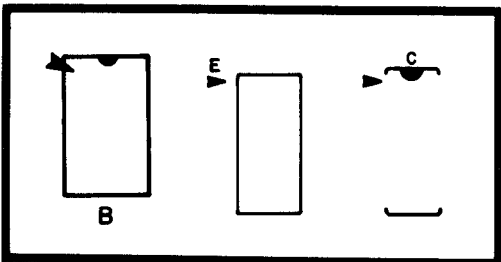

THE DRAWING ON THE LEFT INDICATES VARIOUS METHODS USED TO SHOW THE POSITION OF IC's ON THE PRINTED CIRCUIT BOARDS. THESE ARE SILK-SCREENED DIRECTLY ON THE BOARD. THE ARROWHEAD INDICATES THE POSITION FOR PIN 1 WHEN THE IC IS INSTALLED.



## MOS IC SPECIAL HANDLING PRECAUTIONS

There are several MOS integrated circuits contained in this kit. These IC's are very sensitive to static electricity and transient voltages. In order to prevent damaging these components, read over the following precautions and adhere to them as closely as possible. FAILURE TO DO SO MAY RESULT IN PERMANENT DAMAGE TO THE IC.

- 1) All equipment (soldering iron, tools, solder, etc.) should be at the same potential as the PC board, the assembler, the work surface and the IC itself along with its container. This can be accomplished by continuous physical contact with the work surface, the components, and everything else involved in the operation.
- 2) When handling the IC, develop the habit of first touching the conductive container in which it is stored before touching the IC itself.
- 3) If the IC has to be moved from one container to another, touch both containers before doing so.
- 4) Do not wear clothing which will build up static charges. Preferably wear clothing made of cotton rather than wool or synthetic fibers.
- 5) Always touch the PC board before touching the IC to the board. Try to maintain this contact as much as possible while installing the IC.
- 6) Handle the IC by the edges. Avoid touching the pins themselves as much as possible.
- 7) Dry air moving over plastic can build up considerable static charges. Avoid placing the IC near any such area or object.
- 8) In general, never touch anything to the IC that you have not touched first while touching both it and the IC itself.

## Resistor Installation

Resistors have four (or possibly five) color-coded bands as represented in the chart below. The fourth band is gold or silver and indicates the tolerance. NOTE: In assembling a MITS kit, you need only be concerned with the three bands of color to the one side of the gold or silver (tolerance) band. These three bands denote the resistor's value in ohms. The first two bands correspond to the first two digits of the resistor's value and the third band represents a multiplier.

For example: a resistor with red, violet, yellow and silver bands has a value of 270,000 ohms and a tolerance of 10%. By looking at the chart below, you see that red is 2 and violet is 7. By multiplying 27 by the yellow multiplier band (10,000), you find you have a 270,000 ohm (270K) resistor. The silver band denotes the 10% tolerance. Use this process to choose the correct resistor called for in the manual.

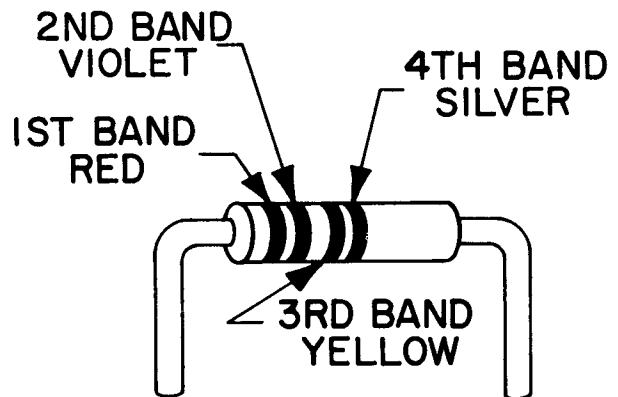

RESISTOR COLOR CODES		
COLOR	BANDS 1&2	3rd BAND (Multiplier)
Black	0	1
Brown	1	10 <sup>1</sup>
Red	2	10 <sup>2</sup>
Orange	3	10 <sup>3</sup>
Yellow	4	10 <sup>4</sup>
Green	5	10 <sup>5</sup>
Blue	6	10 <sup>6</sup>
Violet	7	10 <sup>7</sup>
Gray	8	10 <sup>8</sup>
White	9	10 <sup>9</sup>

Use the following procedure to install the resistors onto the boards. Make sure the colored bands on each resistor match the colors called for in the list of Resistor Values and Color Codes given for each board.

1. Using needle-nose pliers, bend the leads of the resistor at right angles to match their respective holes on the PC board.
2. Install the resistor into the correct holes on the silk-screened side of the PC board.
3. Holding the resistor in place with one hand, turn the board over and bend the two leads slightly outward.
4. Solder the leads to the foil pattern on the back side of the board; then clip off any excess lead lengths.

## CAPACITOR INSTALLATION

### A. Electrolytic Capacitors

Polarity requirements must be noted on electrolytic capacitors before they are installed.

The electrolytic capacitors contained in your kit may have one or possibly two of three types of polarity markings. To determine the correct orientation, look for the following.

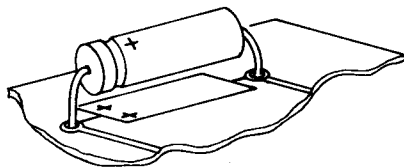

ELECTROLYTIC  
CAPACITOR

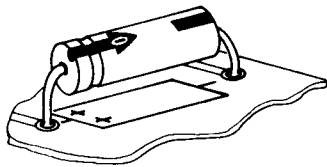
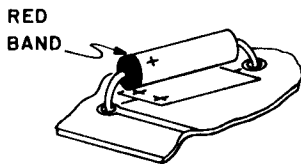

One type will have plus (+) signs on the positive end; another will have a band or a groove around the positive side in addition to the plus signs. The third type will have an arrow on it; in the tip of the arrow there is a negative (-) sign and the capacitor must be oriented so the arrow points to the negative polarity side.

Refer to the chart included for each board for correct Capacitor Values and install the electrolytic capacitors.

1. Bend the two leads of the capacitor at right angles to match their respective holes on the board. Insert the capacitor into the holes on the silk-screened side of the board. Be sure to align the positive polarity side with the "+" signs printed on the board.
2. Holding the capacitor in place, turn the board over and bend the two leads slightly outward. Solder the leads to the foil pattern and clip off any excess lead lengths.

### B. Ceramic Disk Capacitors

Refer to the chart included for each board for correct Capacitor Values, and install the ceramic disk capacitors using the following procedure.

1. Choose the correct value capacitor and straighten the two leads as necessary to fit their respective holes on the PC board.
2. Insert the capacitor into the correct holes from the silk-screened side of the board. Push the capacitor down until the ceramic insulation almost touches the foil pattern.
3. Holding the capacitor in place, turn the board over and bend the two leads slightly outward.
4. Solder the two leads to the foil pattern on the back side of the board; then clip off any excess lead lengths.

IC SOCKET INSTALLATION

Install the following 10 IC sockets according to the instructions on page 4

- (.) Sockets A, B, C, D, F, H, K, and M are 14-pin.
- (.) Sockets J and N are 16-pin.

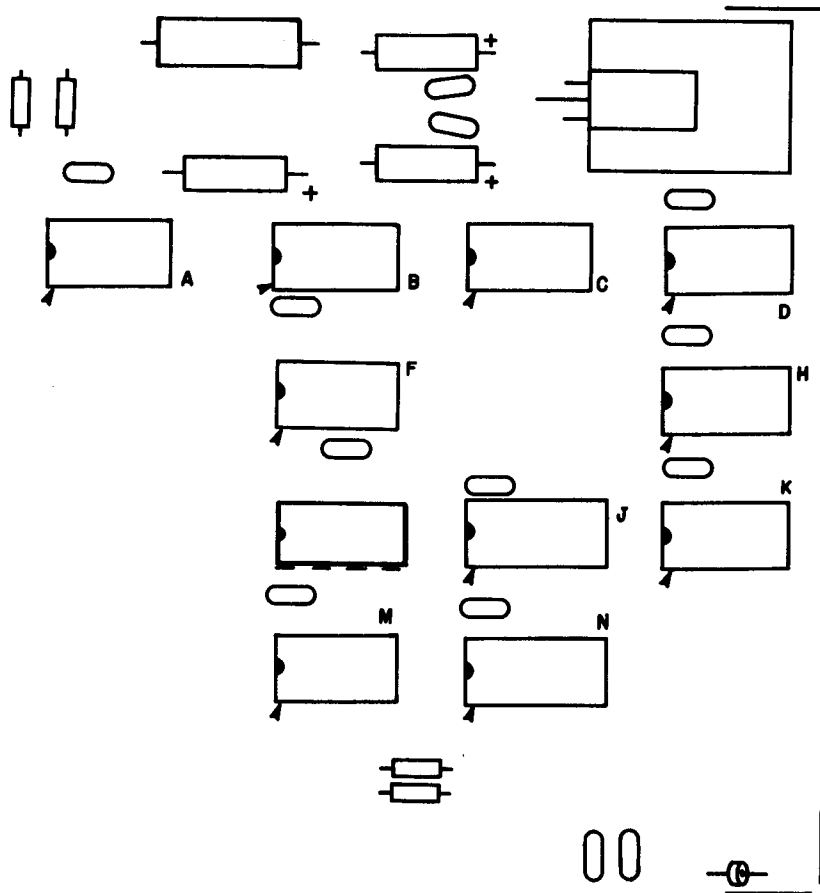

RAM SOCKET INSTALLATION

Install the following 32 sockets according to the instructions on page 4.

All 32 of the RAM sockets are 16-pin.

( ) A0 through 7

( ) B0 through 7

( ) C0 through 7

( ) D0 through 7

NOTE: All 32 RAMs are static-sensitive and must not be installed at this time.

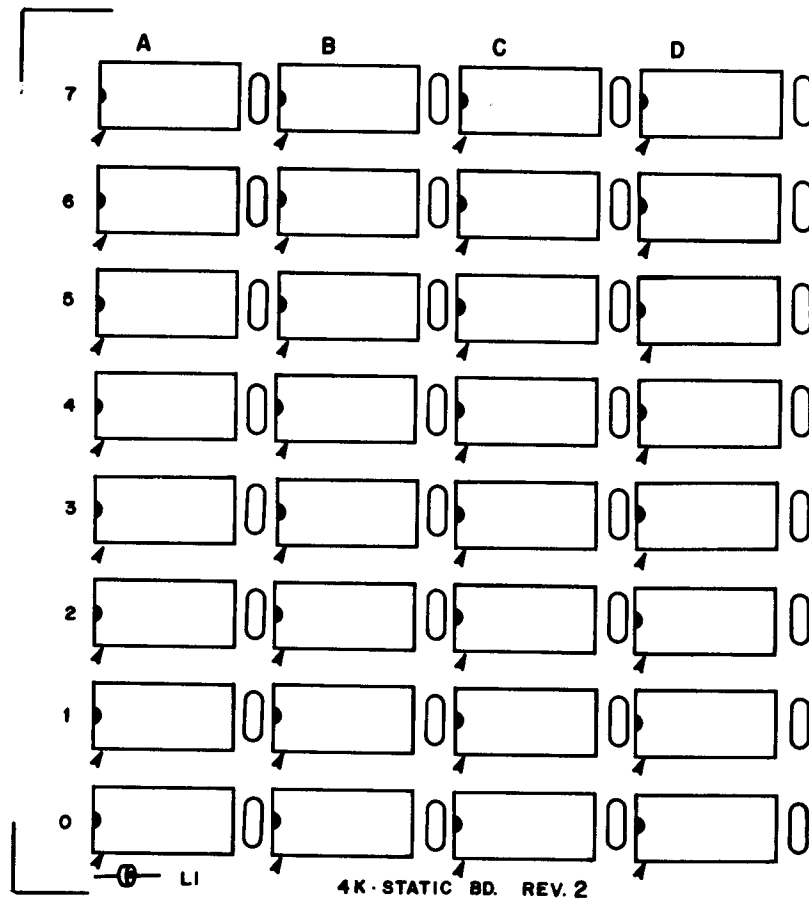

Resistor Installation

Install the following resistors according to the instructions on page 7

- (.) R1 and R2 are 2.2K ohms (red-red-red) 1/2 or 1/4 W.
- (.) R3\* is a 1 ohm wire-wound resistor, 5W.
- (.) R5 and R6 are 100 ohms (brown-black-brown) 1/2 or 1/4 W.

NOTE: Save the leads you clip off for later use.

\* R3 should be installed according to the instructions on page 7, except that R3 should rest 1/8" above the board, not next to the board.

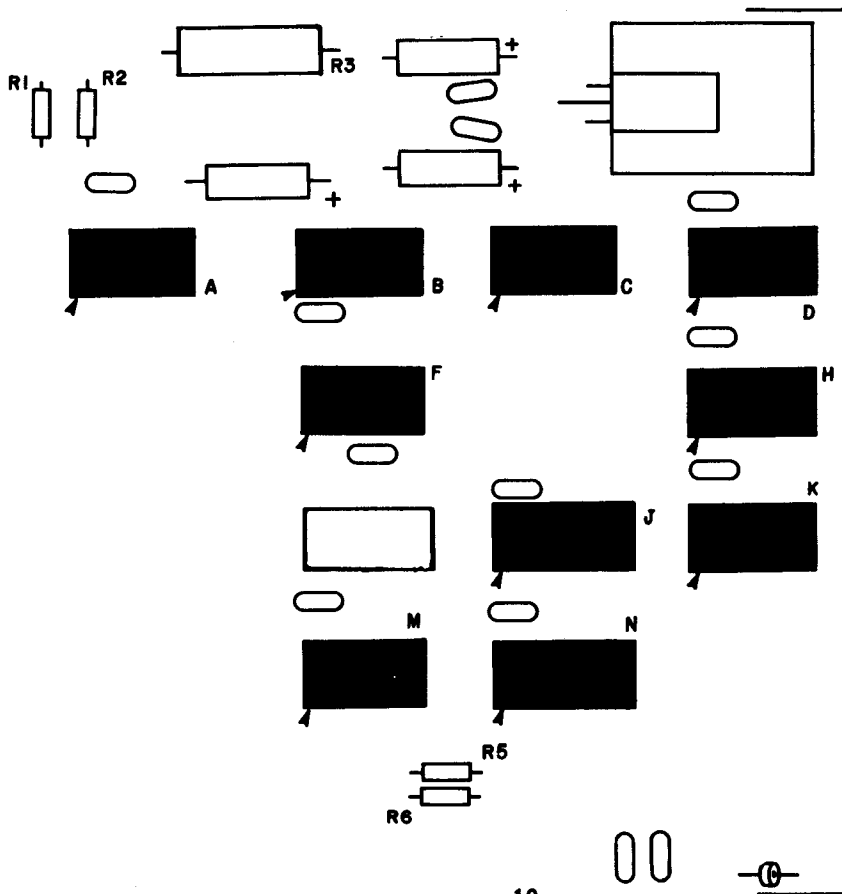

CAPACITOR INSTALLATION

Install the following capacitors according to the instructions on page 8.

- (v) C1, C4 and C5 are 33 or 35 uf/16v electrolytics.
- (v) C2 is a 1 uf/20v electrolytic.
- (v) C3 is a .1 uf ceramic disk.
- (v) C6 and C7 are .01 uf/16v-1Kv ceramic disks.

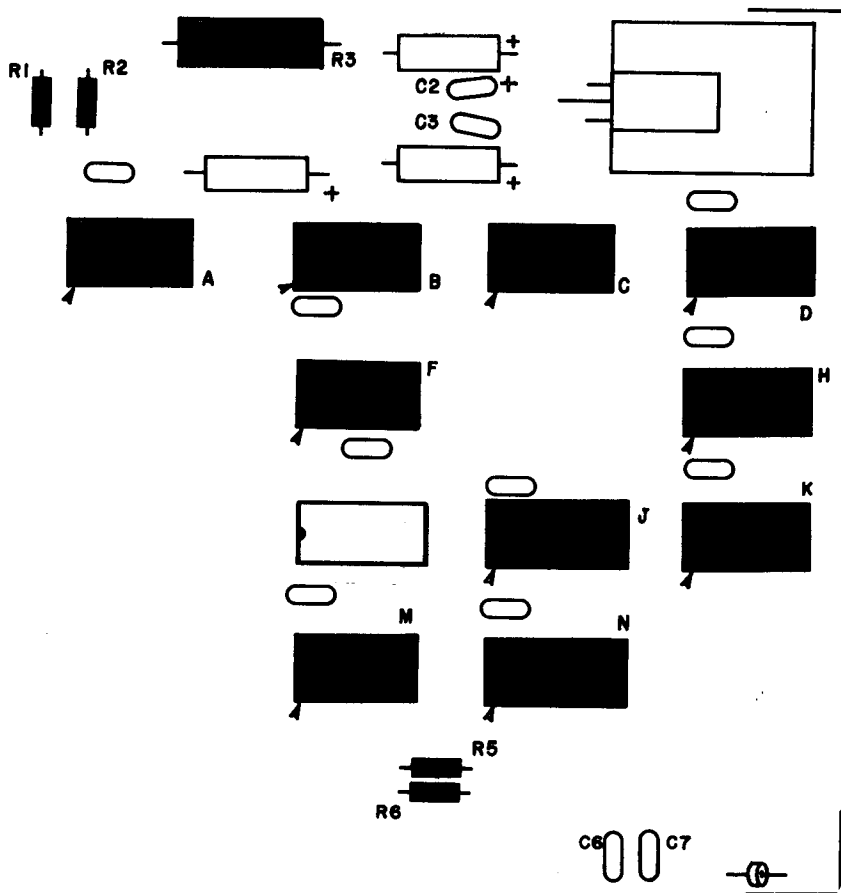

## CAPACITOR INSTALLATION

Install the following ceramic disk capacitors according to the instructions on page 8.

These capacitors are marked only with an outline on the silk-screen; there are no component designations printed for them. These capacitors are located near the ICs, and are used for noise suppression.

- (/) Install 9 suppressor capacitors  
(right side of board)  
.1 uf/12-16v ceramic disks

\* The capacitor located directly above I.C. "D" is incorrectly marked on your PC board. Place the capacitor in the position indicated by the component layout.

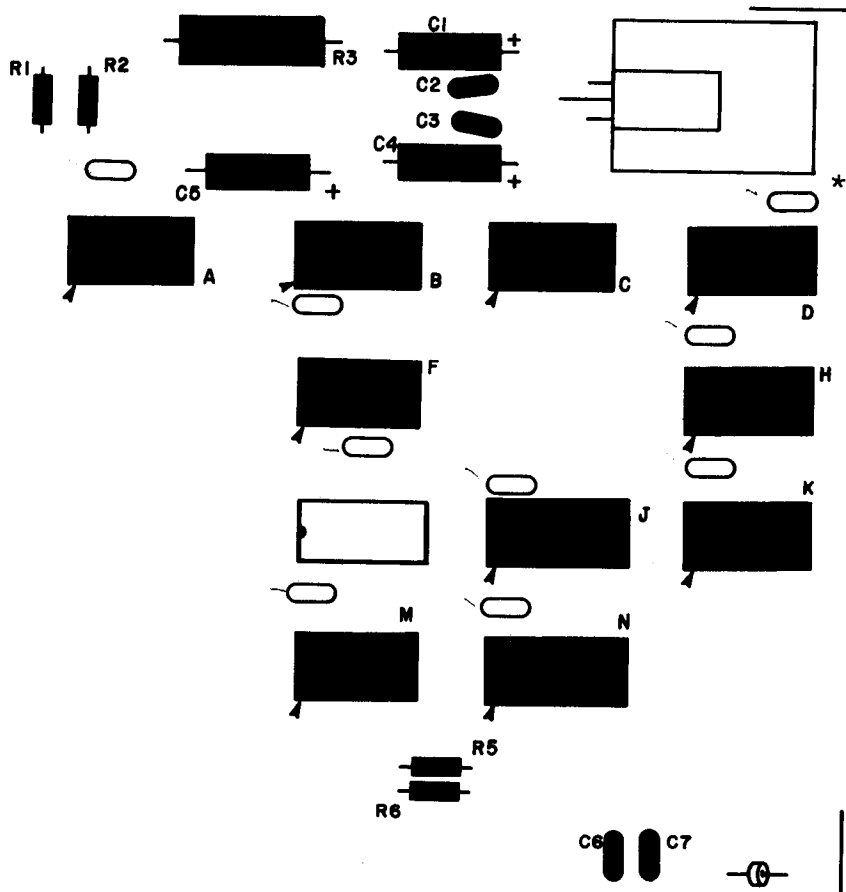



### FERRITE BEAD INSTALLATION

There are 2 ferrite beads to be installed on the board to aid in noise suppression, L1 and L3.

These are to be mounted by placing them over resistor leads (saved earlier) and bending the leads as necessary to fit the proper holes. (See drawing below.)

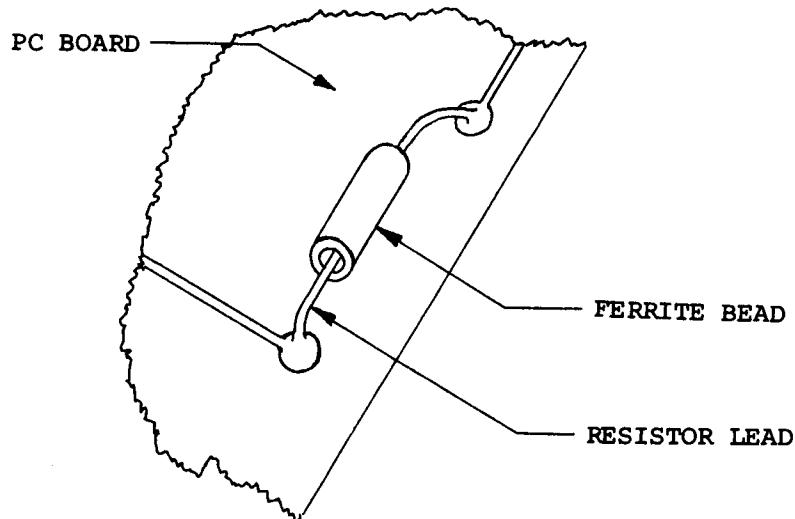

Install them as close to the board as possible on the silk-screened side. Solder them on the back side of the board and clip off the excess lead lengths.

### Ferrite Bead Installation

( ) L1

(✓) L3

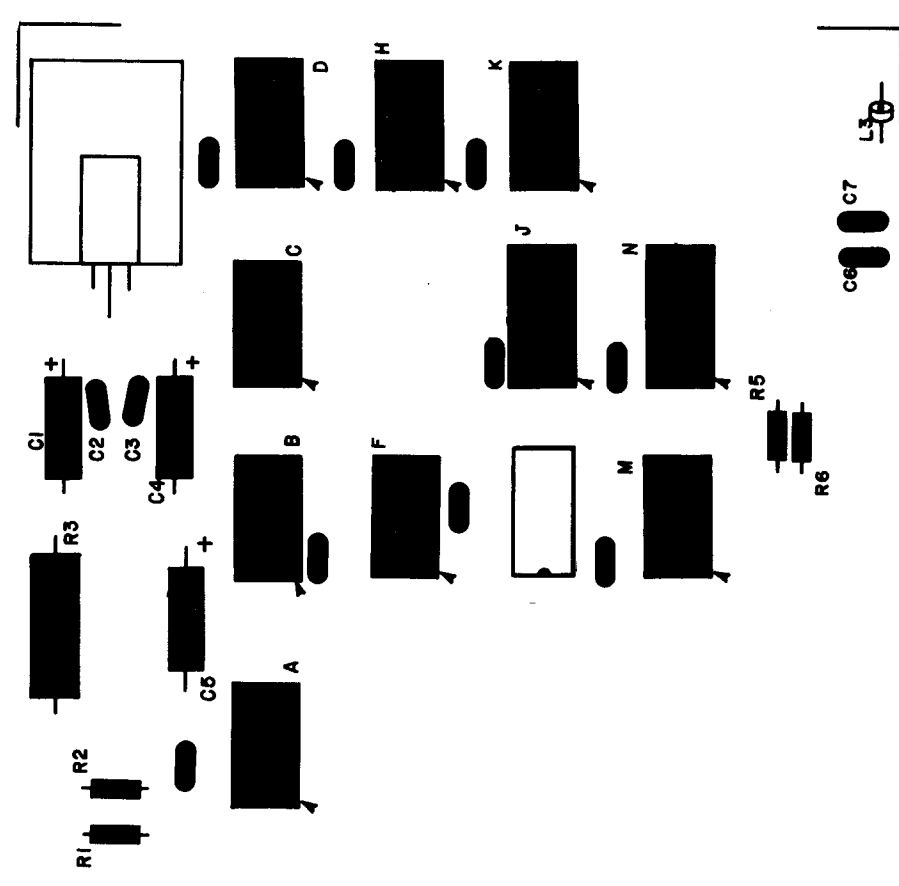
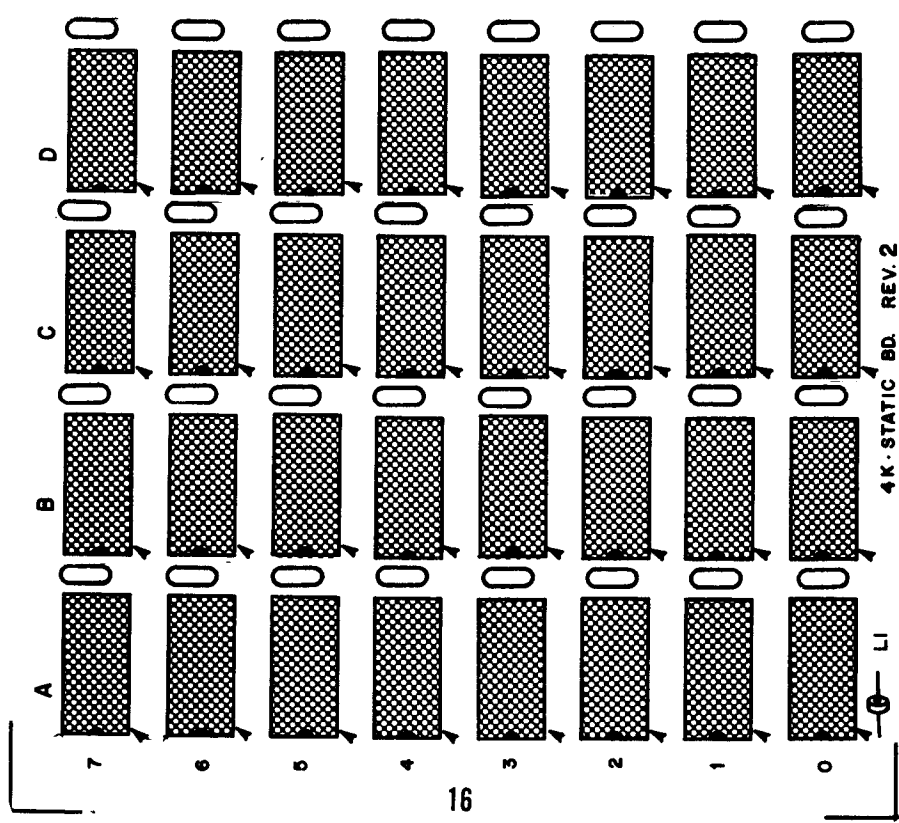

## VOLTAGE REGULATOR INSTALLATION

There is one voltage regulator to be installed on the silk-screened side of the board.

This is to be installed according to the following procedure. (See drawing.)

- (1) Set the regulator in place over the board so that the mounting hole in the regulator and the board align.
- (2) Use a pencil to mark the point on each of the regulator's three leads directly over its corresponding hole in the board.
- (3) Bend the three leads, using needle-nose pliers, at right angles from the printed side of the component.

**NOTE:** Use heat-sink grease when installing this component. Apply the grease to all surfaces which come in contact with each other.

- (4) Referring to the drawing, set the regulator and heat sink in place on the silk-screened side of the board. Secure them to the board using a #6-32 nut. Hold the regulator in place as you tighten the nut to keep from twisting the leads.
- (5) Turn the board over and solder the three leads to the foil pattern on the back side of the board. Be sure not to leave any solder bridges.
- (6) Clip off any excess lead lengths.

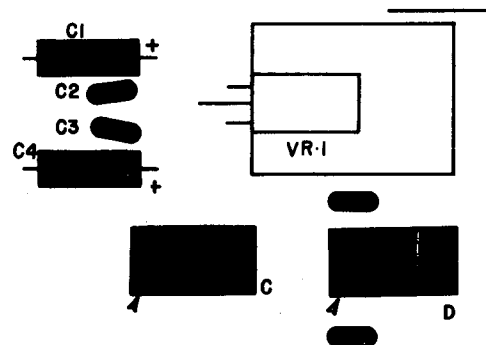
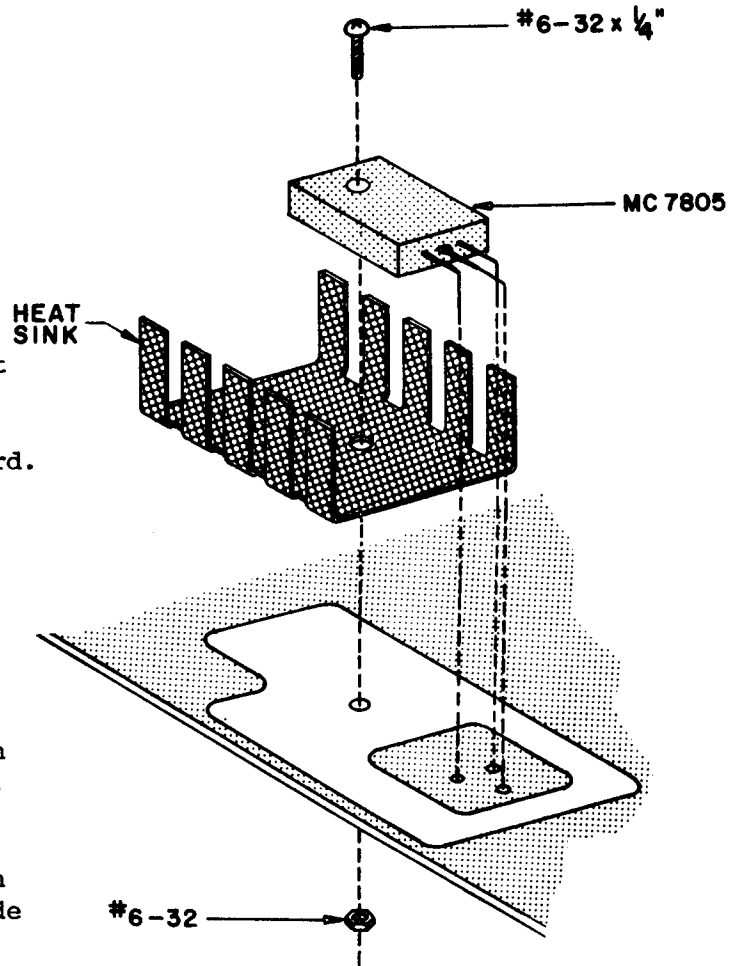

ADDRESS SWITCH INSTALLATION

There is one address line switch to be installed on the 88-4MCS.

Referring to the component layout on this page, install the address switch according to the following procedure.

- (1) Remove the switch from its holder. If there are any bent pins, straighten them with needle-nose pliers.
- (2) Orient the switch so that the numbers 1, 2, 3, and 4 on the switch line up directly under A12, A13, A14 and A15 respectively. Note the following illustration.

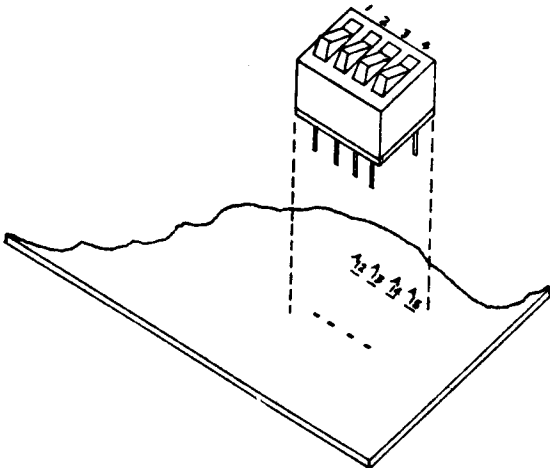

- (3) Start the pins on one side of the switch into their respective holes on the silk-screened side of the board. DO NOT PUSH THE PINS IN ALL THE WAY. If you have difficulty getting the pins into the holes, use the tip of a small screwdriver to guide them.

- (4) Start the pins on the other side of the switch into their holes in the same manner. When all of the pins have been started, set the IC into place by gently rocking it back and forth until it rests as closely to the board as possible. After you are certain that the switch is straight, tape it in place with a piece of masking tape.
- (5) Turn the board over and solder each pin to the foil pattern on the back side of the board. Be sure to solder EACH pin, and be careful not to leave any solder bridges.
- (6) Turn the board over again, and remove the piece of masking tape.

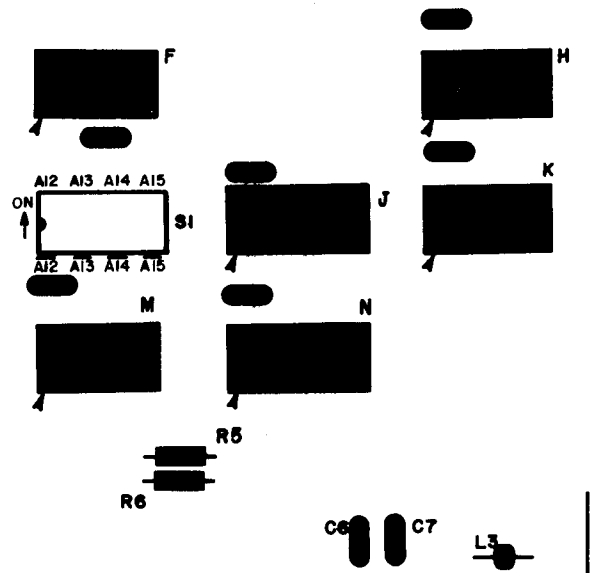

RAM & CAPACITOR INSTALLATION

RAMs A0-A7, B0-B7, C0-C7 and D0-D7 should be installed now.

- (1) Review the "MOS IC Special Handling Procedures" on page 5 of the ALTAIR 8800 Assembly Manual. Note, failure to carefully follow the instructions of the "MOS Special Handling Procedures" may result in permanent damage to static-sensitive ICs.
- (2) Insert the RAMs into their sockets on the 88-4MCS. Handle the RAMs carefully, and use as little pressure as possible when inserting the RAMs. Note that RAMs A0-A7, B0-B7, C0-C7 and D0-D7 are 2102A-4s.

- (3) After the RAMs have been installed, pick up the 88-4MCS and view each row at eye level to be certain that all of the pins have been properly inserted.

There are 32 suppressor capacitors to be installed. These capacitors are marked only by an outline on the silkscreen; there are no component designations for them. They are located next to the RAMs and are used for noise suppression. Install these disk capacitors according to the instructions on page 8.

- (4) Install 32 suppressor capacitors (left side of board) .1 uf/12-16v ceramic disks

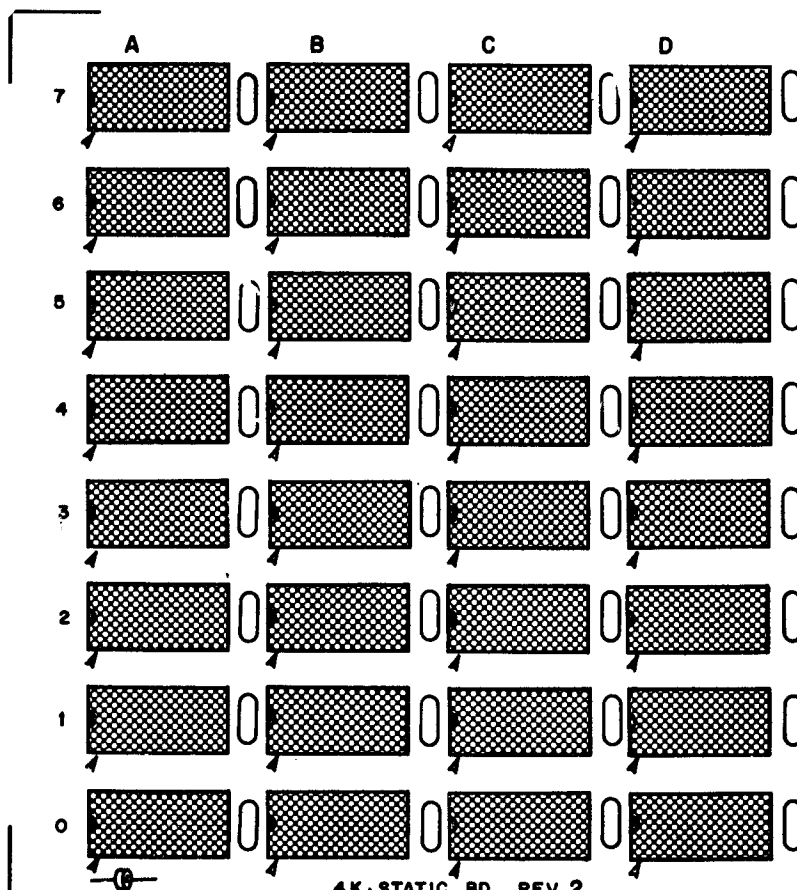

## BOARD INSTALLATION

The edge connector and card guide provided with the board must be installed. Install the edge connector according to the procedure described on page 64 in the assembly manual "EXPANDER BOARD 8800 M/BD ASSEMBLY". Install the card guide according to the procedure described on page 68 in the assembly manual "EXPANDER BOARD 8800 M/BD ASSEMBLY".

Press the 88-4MCS into the edge connector. The board should be oriented so that the silk-screened side faces the right side of the unit viewed from the front panel.

### **NOTE**

If you have trouble plugging the card in, measure the stab width of the board. It should be slightly less than 6 3/8" long. File the stab width, if necessary, and try again.